



# INSTALLATION INSTRUCTIONS AND OWNER'S MANUAL

The *White Mountain* Log Collection

## **PONDEROSA**



**LOG SET FOR UNVENTED  
GAS LOG HEATER  
OR  
VENTED DECORATIVE APPLIANCE**

### **MODELS**

**LS-18P-2**

**LS-24P-1**

**LS-30P-1**

**WARNING:** If the information in these instructions are not followed exactly, a fire or explosion may result causing property damage, personal injury or loss of life.

- Do not store or use gasoline or other flammable vapors and liquids in the vicinity of this or any other appliance.
- **WHAT TO DO IF YOU SMELL GAS**
  - Do not try to light any appliance.
  - Do not touch any electrical switch; do not use any phone in your building.
  - Immediately call your gas supplier from a neighbor's phone. Follow the gas supplier's instructions.
  - If you cannot reach your gas supplier, call the fire department.
- Installation and service must be performed by a qualified installer, service agency or the gas supplier.



**Installer:** Leave this manual with the appliance.

**Consumer:** Retain this manual for future reference.

Log sets comply with ANSI Z21.11.2 Unvented Heaters and also comply with ANSI Z21.60 Decorative Vented Appliances for Solid Fuel Burning Fireplaces. State or local codes may only allow operation of log sets in a vented configuration. Check your state or local codes.

**WARNING:** If not installed, operated and maintained in accordance with the manufacturer's instructions, this product could expose you to substances in fuel or from fuel combustion which can cause death or serious illness.

# TABLE OF CONTENTS

<b>Section</b>	<b>Page</b>
Important Installation Guidelines .....	3
General Information .....	3
Requirements for Canada .....	4
Log Placement .....	5 - 16
Parts List & Parts View .....	17
Placement of Glowing Embers LS-18P-2 .....	18 - 19
Placement of Glowing Embers LS-24P-1 .....	20 - 21
Placement of Glowing Embers LS-30P-1 .....	22 - 23
Placement of Glowing Embers .....	24
Master Parts Distributor List .....	25
How To Order Repair Parts .....	25
Service Notes .....	26 - 27

# IMPORTANT INSTALLATION GUIDELINES

## **Proper Log Placement**

Log placement is critical to proper burner performance. Logs must be correctly positioned onto the burner. The photos in this manual show the proper pinned position for logs on this set. Owners need to be shown proper log placement and instructed not to move the logs.

Logs must fit firmly onto the burner when positioned as shown in the photos. Malformed logs or logs with sloppy pin holes must be replaced.

## **Proper Placement of Glowing Embers and Decorative Lava Rock**

Glowing embers can be added to burners for a glowing ember effect. It must be positioned only on the front portion of the burner. The photos in this manual show the proper placement of glowing embers.

Decorative lava rock or small wood pieces should never be placed on the burner. These items are only for placement on the floor of the fireplace or firebox.

## **Proper Primary Airflow into Burner**

For proper burner operation and flame appearance, the flow of primary air into the venturi tube, located on the rear of the burner, must not be reduced. This flow of air is reduced if dirt, lint or other obstructions build-up around or inside the venturi. Any obstruction in the venturi tube area must be removed. The flow of air into the venturi is also reduced if the gas orifice isn't centered in the venturi inlet and/or is not aligned with the venturi. Any misalignment of the burner orifice may be corrected by bending the shutter cap holding the orifice to the inlet of the venturi tube.

## **Ceiling Fans, Portable Fans or Logs Installed Near Cold Air Returns**

Ceiling fans or oscillating floor type fans need to be monitored during the operation of vent-free logs. If the air blows directly into the flame causing it to impinge on the log set, or firebox, it should be turned off or redirected. Ceiling fans could be reversed to possibly eliminate flame impingement, and the floor fan could be redirected. Upon installation, be aware of any cold air returns or vents in the proximity of the log set. Any draft created around

a vent-free log set can cause the flame to impinge on the log and create a sooting situation.

**WARNING:** Do not allow fans to blow directly into the fireplace. Avoid any drafts that alter burner flame patterns.

**WARNING:** Do not use a blower insert, heat exchanger insert or other accessory not approved for use with this heater.

## **Candles**

Avoid the use of scented or decorative candles while the log set is in operation. Candles produce a residue in the air that creates a soot like substance. Burning candles while the log set is operating magnifies the problem. It should be noted that candles, in general, produce soot. The amount of time burned and the quantity of candles burned will determine the amount of soot produced and deposited.

## **Make Owners Aware of Proper Log Set Operation**

Properly installed and properly maintained log sets do not deposit soot on the logs. If users see soot appear on a log, call for service. Do not continue to operate the log set.

## **Sunken Fireplace**

If installing this unit into a sunken fireplace, you must raise the floor to insure adequate airflow and guard against sooting. Raise fireplace floor using a non-combustible material, which is secure.

## **Glass Doors**

Make sure that glass doors are open during all operations of the logset. The opening of the glass door frame should be the dimension used for the minimum front opening of the firebox.

## **Woodburning Fireplaces**

The interior of the firebox and the chimney should be cleaned and free of all creosote before installing a gas burning log set. Creosote will soften when heated and can drop on the logset causing odors and possibly sooting.

**WARNING:** Before installing in a solid-fuel burning fireplace, the chimney flue and firebox must be cleaned of soot, creosote, ashes and loose paint by a qualified chimney cleaner.

# GENERAL INFORMATION

## **Qualified Installing Agency**

Installation and replacement of gas piping, gas utilization equipment or accessories and repair and servicing of equipment shall be performed only by a qualified agency. The term "qualified agency" means any individual, firm, corporation, or company that either in person or through a representative is engaged in and is responsible for (a) the installation, testing, or replacement of gas piping or (b) the connection, installation, testing, repair, or servicing of equipment; that is experienced in such work; that is familiar with all precautions required, and that has complied with all the requirements of the authority having jurisdiction.

The installation must conform with local codes or, in the absence of local codes, with the *National Fuel Gas Code, ANSI Z223.1/NFPA54*.\*

\*Available from the American National Standards Institute, Inc. 11 West 42nd St., New York, N.Y. 10018.

**State of Massachusetts:** The installation must be made by a licensed plumber or gas fitter in the Commonwealth of Massachusetts.

Sellers of unvented propane or natural gas-fired supplemental room heaters shall provide to each purchaser a copy of 527 CMR 30 upon sale of the unit.

In the State of Massachusetts, unvented propane and natural gas-fired space heaters shall be prohibited in bedrooms and bathrooms.

# REQUIREMENTS FOR CANADA

This unit **cannot** be installed in an UNVENTED application, this unit **can only** be installed in a VENTED application with these requirements.

## IMPORTANT SAFETY INFORMATION

This unit complies with ANSI Z21.60 and CGA 2.26 Decorative Gas Appliances For Installation In Solid Fuel Burning Fireplaces. Do not burn wood or solid fuels in a fireplace where a decorative gas log set is installed. This appliance is for installation only in a solid fuel burning fireplace, masonry fireplace or manufactured fireplace.

**Warning:** Any modification to this gas log set or to controls can be dangerous. Improper installation or use of the gas log set can cause serious injury or death from fire, burns, explosion or carbon monoxide poisoning.

1. Please follow all local codes regarding installation, combustion and ventilation air or in the absence of local codes follow the National Fuel Gas Code ANSI Z223.1 (U.S. installation), or CAN/CGA-B149, Installation Code (Canada installation).
2. Proper installation, burner pan location and log placement is important to achieve optimum look and performance of your gas log set. The logs have been designed for easy location and placement on the grate and must be followed for proper operation.
3. Do not operate this log set with glass doors in the closed position. A fireplace screen must be in place when the log set is burning. Adequate combustion air must be provided for proper venting. All flames should go up and out the top of the firebox into the flue vent. If any flames float or curl forward into the room do not operate appliance. Check for an open flue and adequate combustion air into the room. A damper clamp must be installed on the firebox damper to maintain an open flue vent condition. Refer to fireplace owners manual INSTALLING DAMPER CLAMP section.
4. Young children must be carefully supervised when they are in the same room as the gas log while in operation. Do not place stockings, clothing or any flammable material above or near the fireplace.
5. Do not substitute or use materials other than those supplied for use with the log set.
6. Also refer to IMPORTANT SAFETY INFORMATION in the fireplace Owner's Manual.

## **WARNING; DO NOT OPERATE THIS GAS LOG SET WITH GLASS DOORS CLOSED**

- Clothing or other flammable material should not be placed on or near the appliance.
- Do not place trash or other articles on the log set during operation.
- During manufacturing, fabricating and shipping, various components of this appliance are treated with certain oils, films or bonding agents. These bonding agents are not harmful but may produce annoying smoke and smells as they are burned off during initial operation of the appliance. This is a normal temporary occurrence. A window should be opened during the initial bake out period.
- Keep burner and control compartment clean.
- **WARNING:** Before installing in a solid fuel burning fireplace, the chimney flue and firebox must be cleaned of soot, creosote, ashes and loose paint by a qualified chimney cleaner.
- Installation and repair should be done by a qualified service person. The appliance should be inspected before use and at least annually by a qualified service person. More frequent cleaning may be required due to excessive lint from carpeting, bedding materials, etc. It is imperative that control compartments, burners and circulating air passageways of the appliance be kept clean.
- **Do not** put anything around the fireplace that will obstruct the flow of ventilation air.
- **Do** keep the appliance area clear and free from combustible material, gasoline and other flammable vapors and liquids.
- A yearly examination and cleaning of the venting system of the solid-fuel burning fireplace must be performed by a qualified agency.
- **Do** make a periodic visual check of pilot and burners. Clean and replace damaged parts.
- **Do not** use this appliance if any part has been under water. Immediately call a qualified service technician to inspect the appliance and to replace any part of the control system and any gas control which has been under water.
- Never burn solid fuels in a fireplace where a gas log set is installed.
- This unit complies with ANSI Z21.60 Decorative Vented Appliances for Solid Fuel Burning Fireplaces. State or local codes may only allow operation of this appliance in a vented configuration. Check your state or local codes.

# LOG PLACEMENT

Before you begin: Do not handle these logs with your bare hands! Always wear gloves to prevent skin irritation. After handling logs, wash your hands gently with soap and water.

## All Logs

The positioning of the logs is critical to the safe and clean operation of this heater. Sooting and other problems may result if the logs are not properly and firmly positioned in the appliance.

**Warning:** Failure to position the parts in accordance with this diagram or failure to use only parts specifically approved with this appliance may result in property damage or personal injury.

## PROPER INSTALLATION SEQUENCE:

### LS-(18, 24, 30)P

1. Place front left (A) log onto burner pan pins.

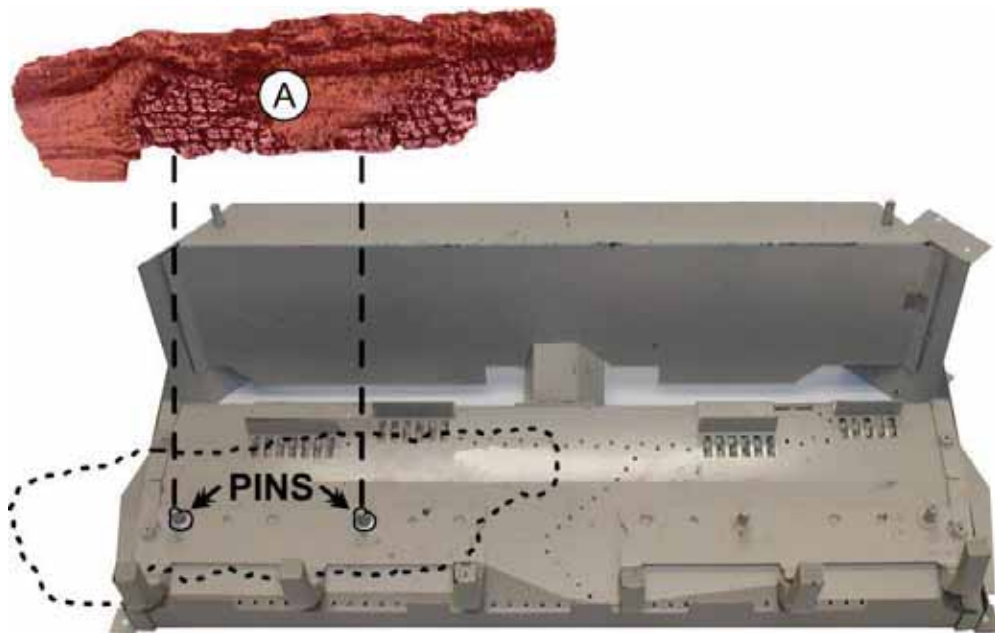

FRONT VIEW

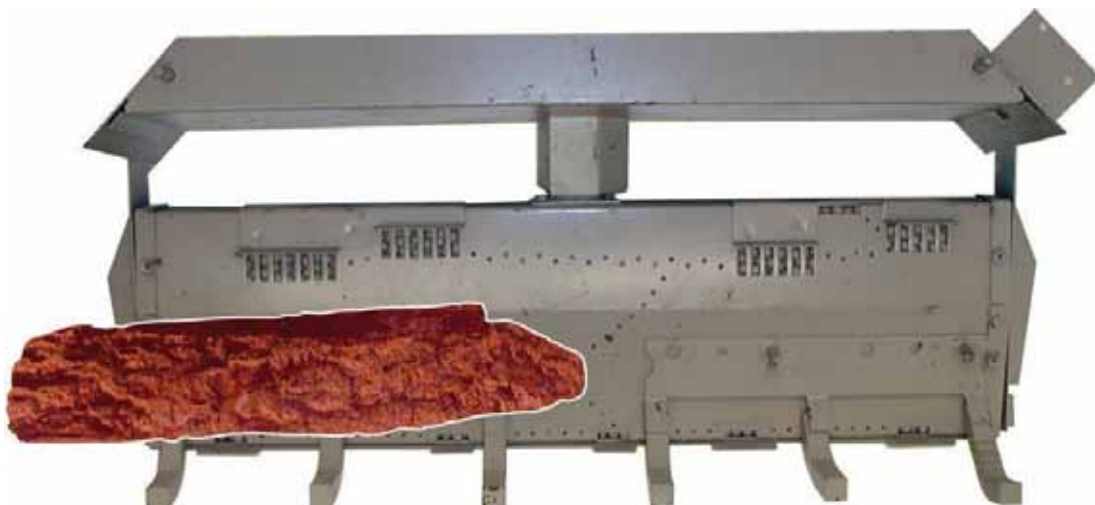

TOP VIEW

# LOG PLACEMENT

2. Place rear left (B) log between rear log support and front left log (A)

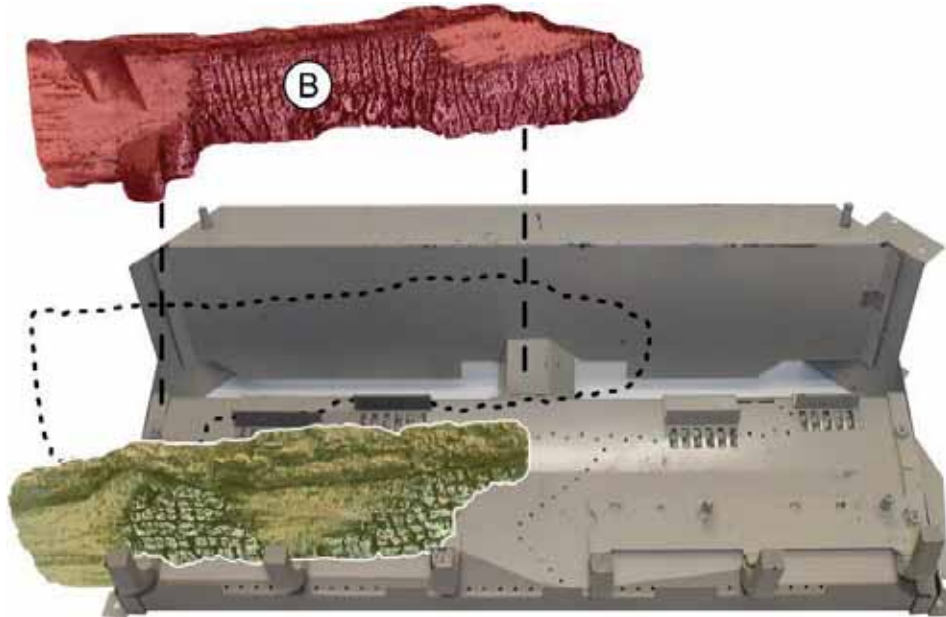

**FRONT VIEW**



**TOP VIEW**

# LOG PLACEMENT

3. Place rear right (C) log between rear log support and burner pan, resting on right side of burner pan.

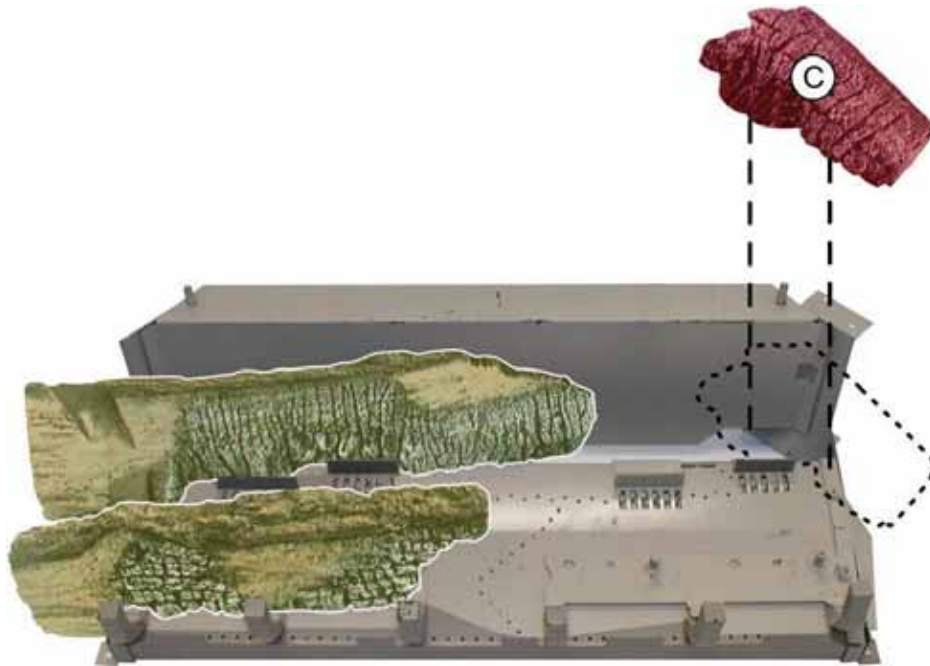

**FRONT VIEW**



**TOP VIEW**

# LOG PLACEMENT

4. Place front right (D) log onto pins on burner pan.

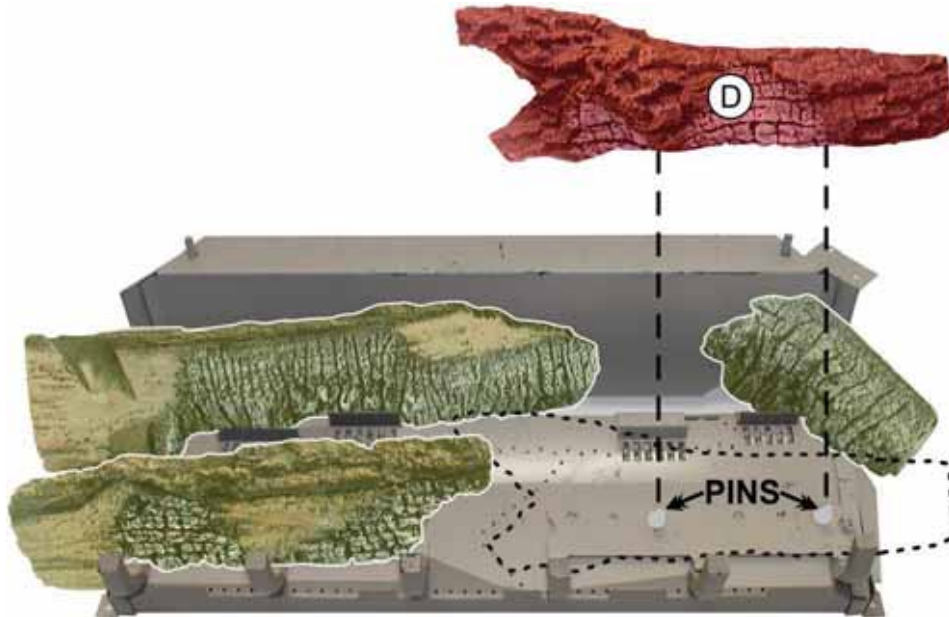

**FRONT VIEW**

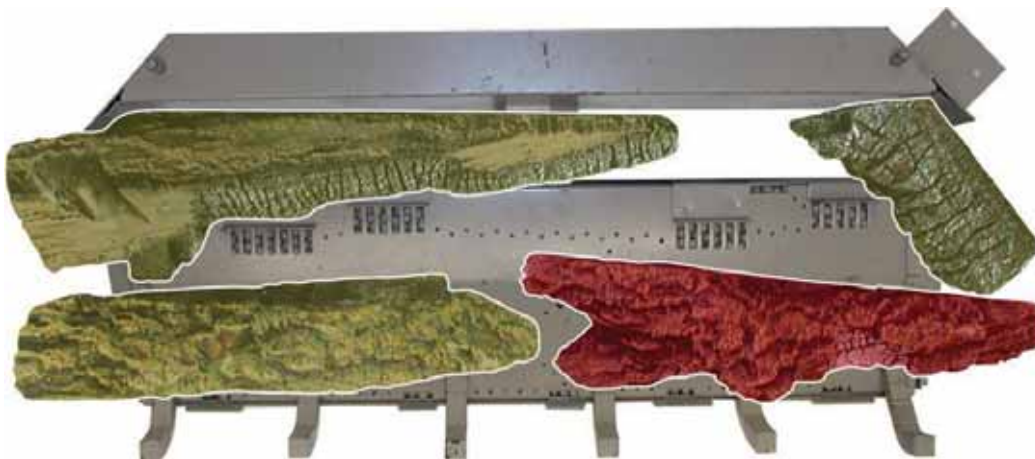

**TOP VIEW**

# LOG PLACEMENT

5. Place rear center (E) log onto left pin of rear log support.

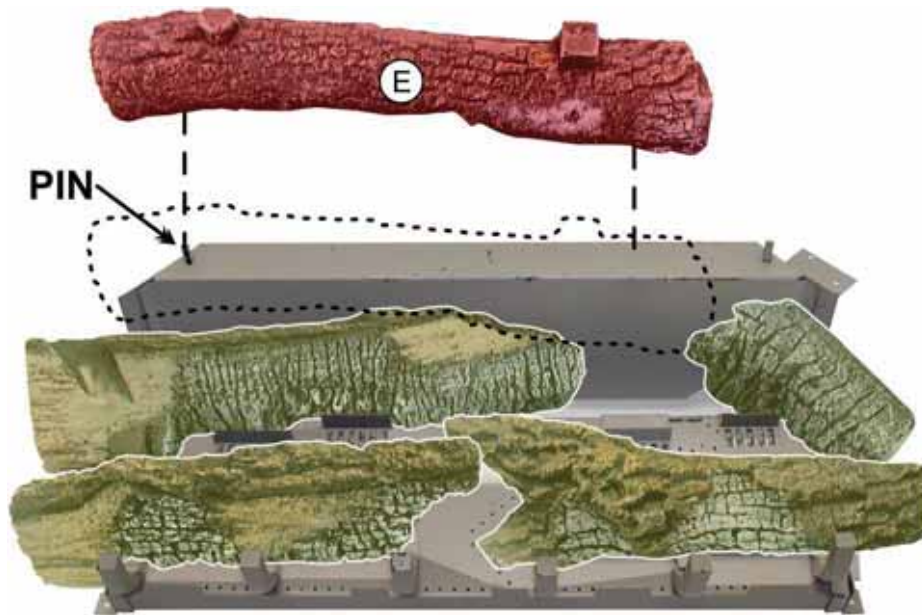

**FRONT VIEW**

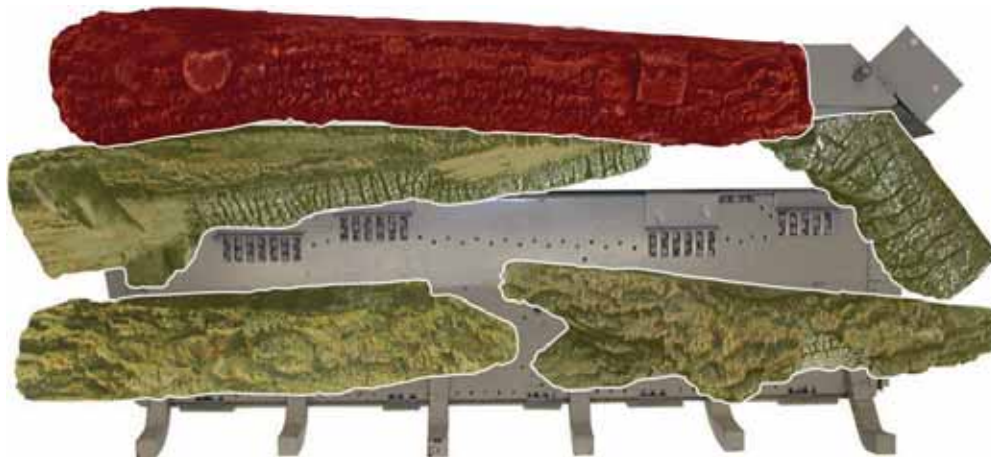

**TOP VIEW**

# LOG PLACEMENT

6. Place boss on middle left (F) log into recess on rear left (B) log and front left (A) log.
7. Place middle right (G) log onto the right pin of rear log support and resting on rear right (C) log.

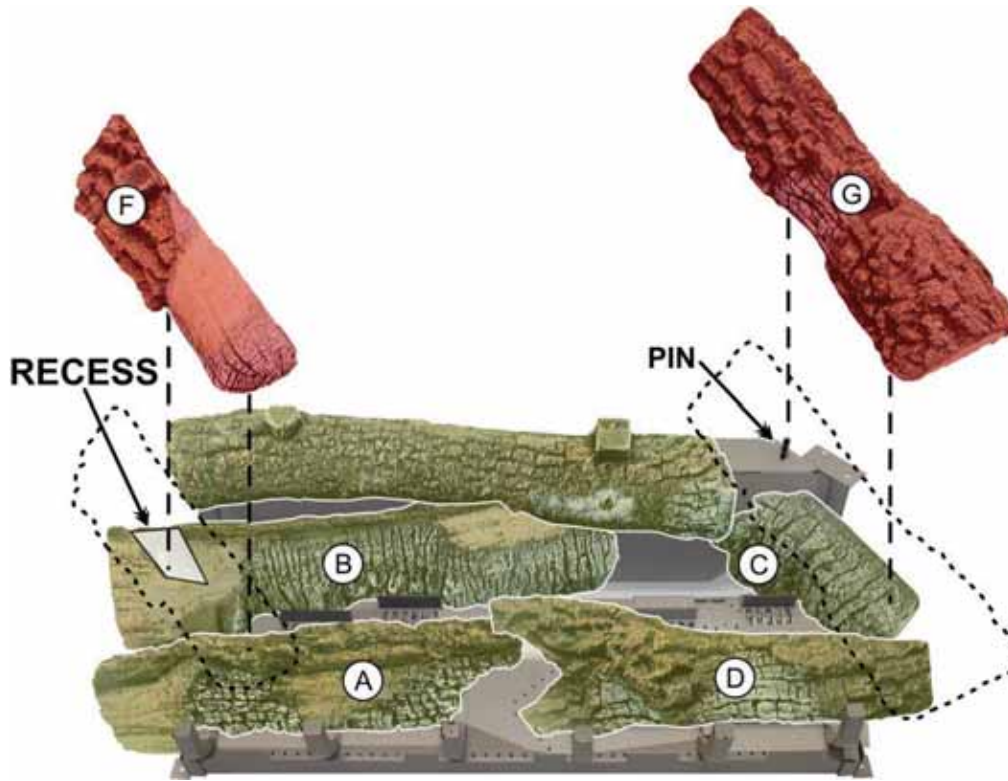

FRONT VIEW

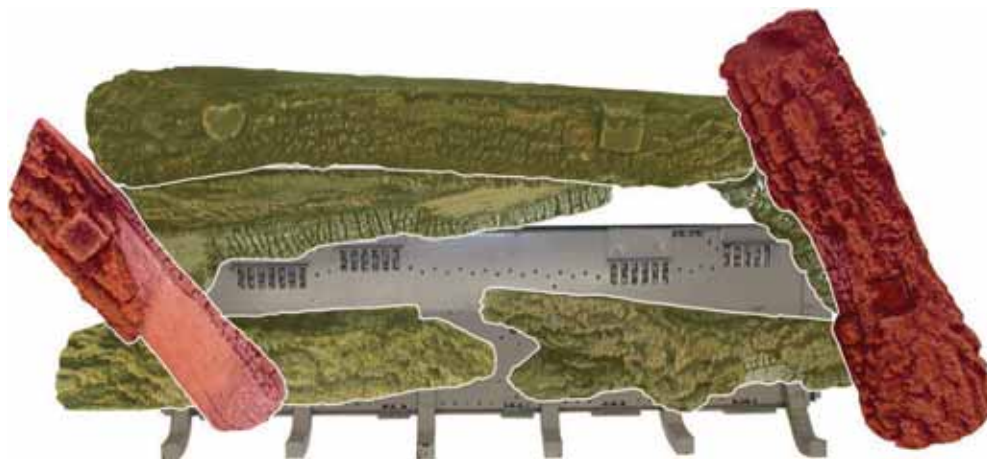

TOP VIEW

# LOG PLACEMENT

8. Insert boss on upper, middle right (H) log into recess on middle right (G) log and resting on front grate bar
9. Place square recess in upper, middle left (J) log onto square boss on middle left (F) log and round recess in upper middle left (J) log onto boss on rear center (E) log.

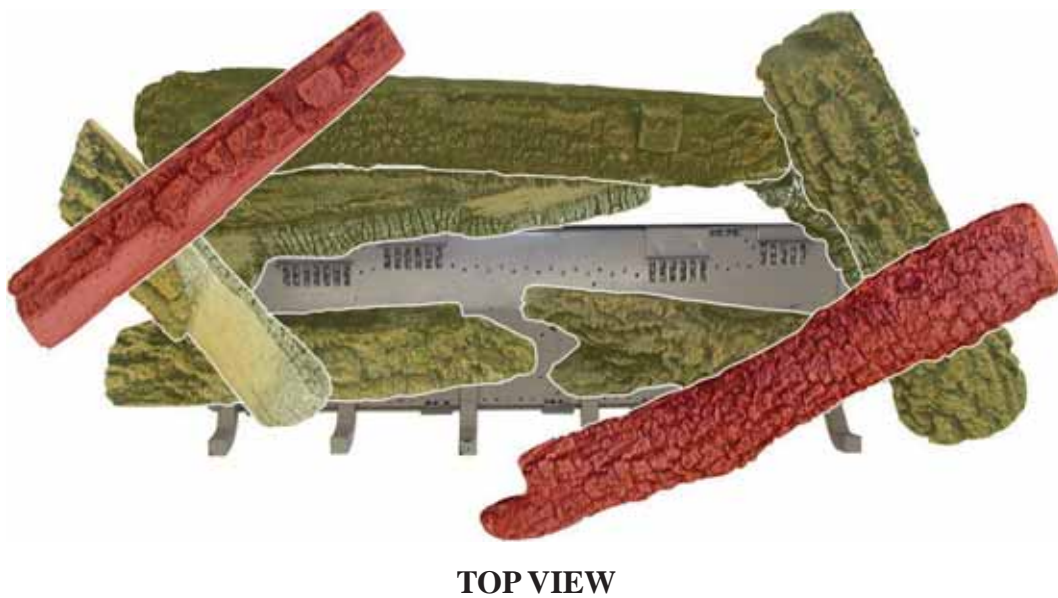
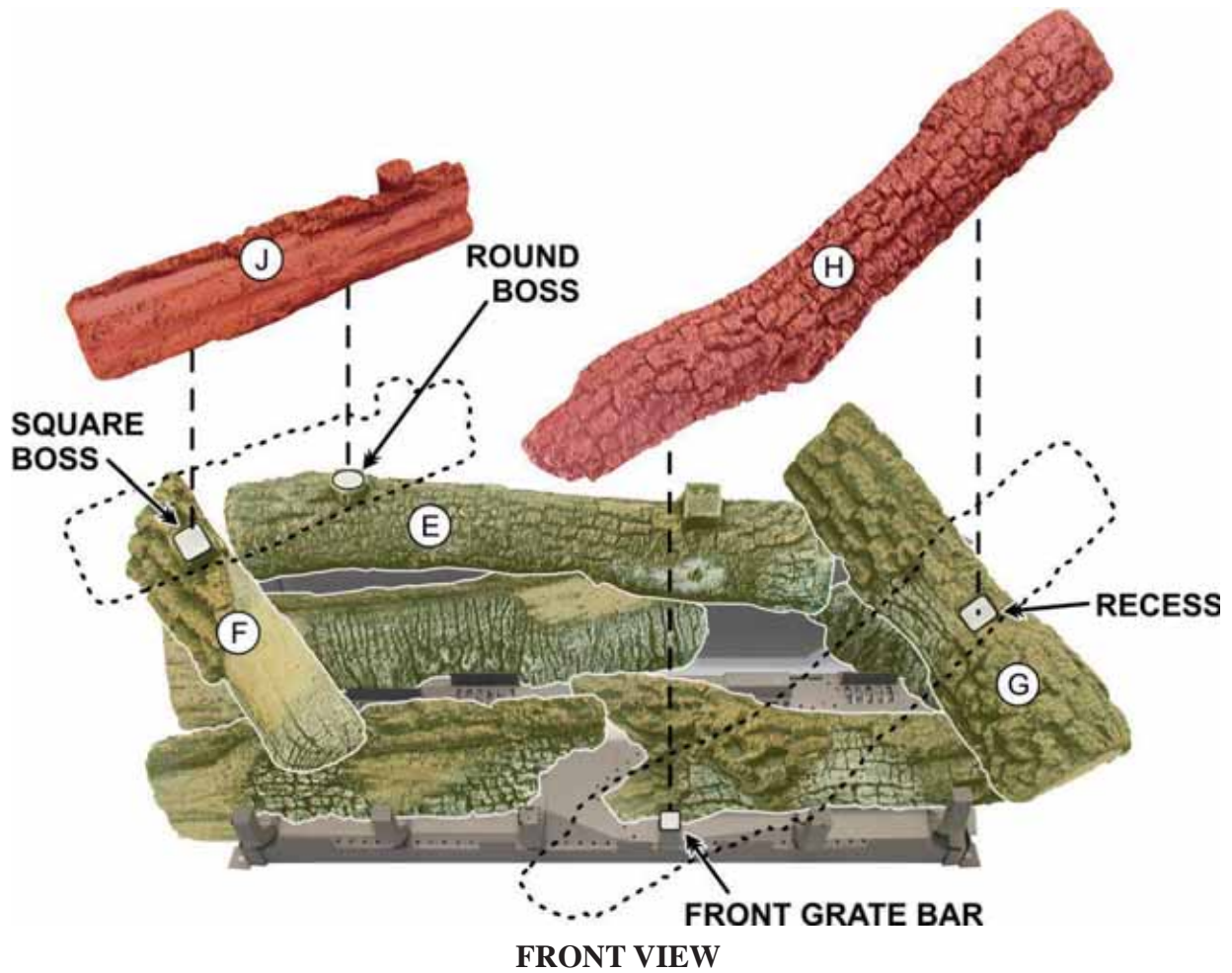

# LOG PLACEMENT

10. Place recess in middle center (I) log onto boss on rear center (E) log and resting on front left (A) log.

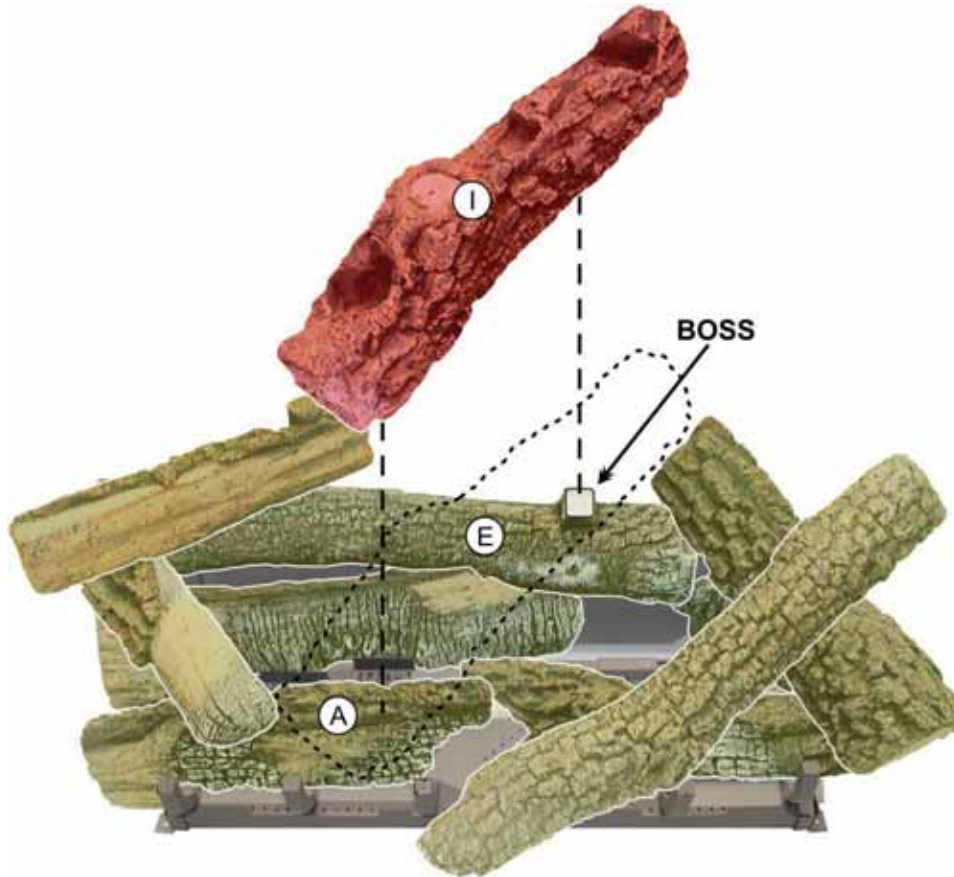

**FRONT VIEW**

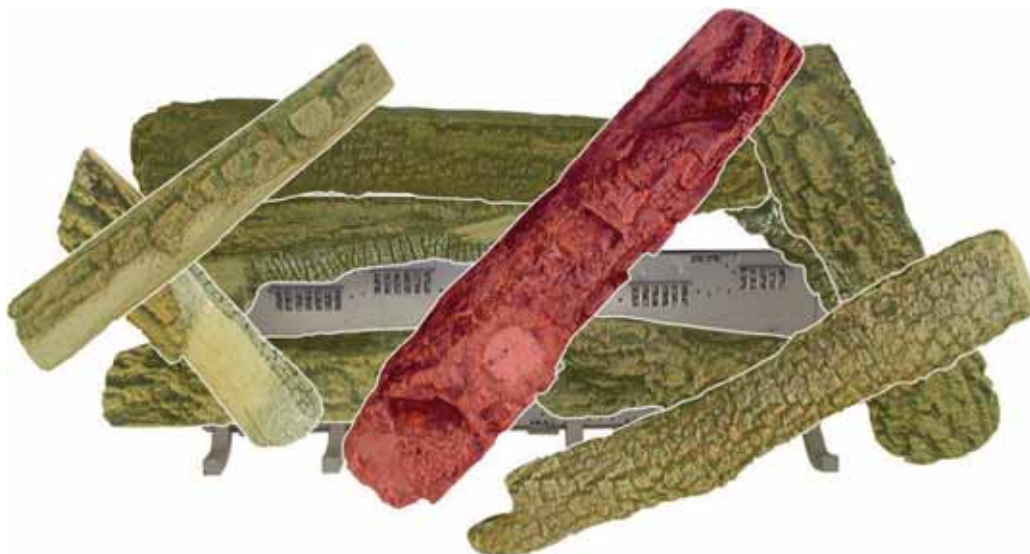

**TOP VIEW**

# LOG PLACEMENT

11. Place round recess in top center (K) log onto round boss on upper middle left (J) log and insert square boss on top center (K) log into square recess in middle center (I) log.

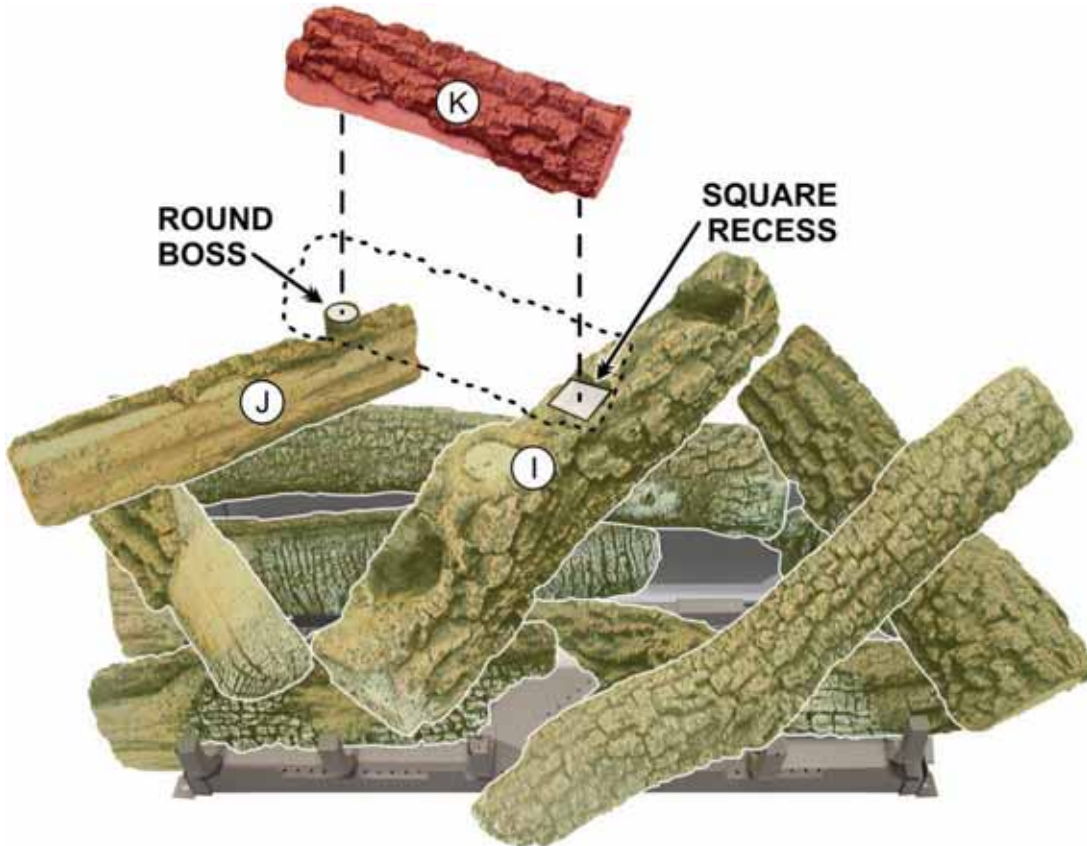

**FRONT VIEW**

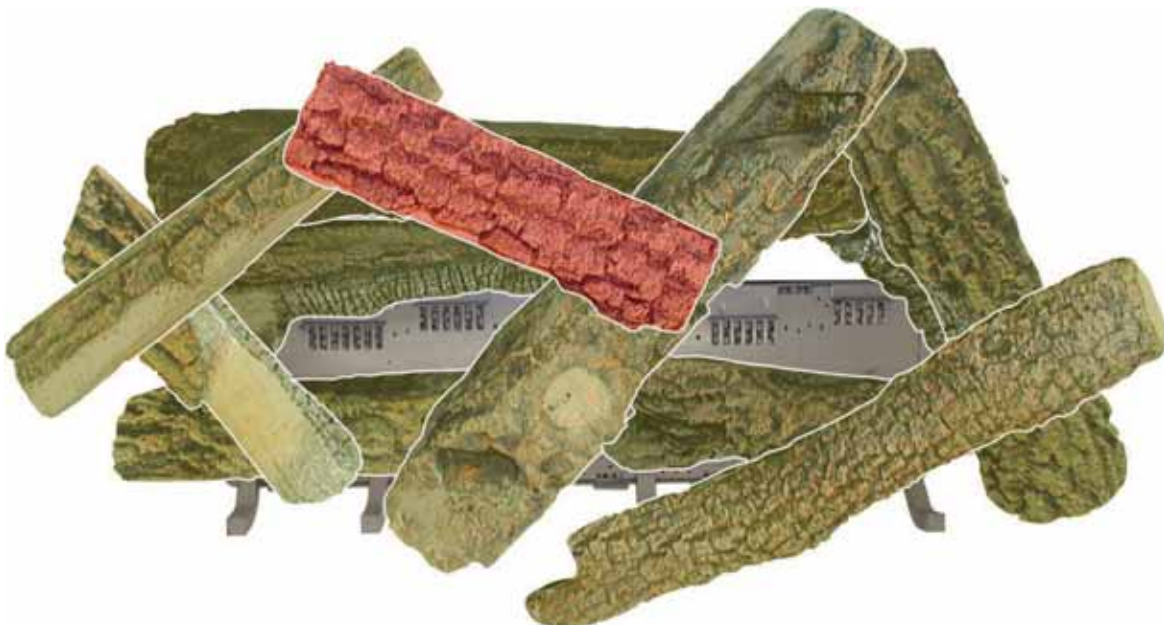

**TOP VIEW**

# LOG PLACEMENT

12. Insert boss on top right (L) log into recess on middle center (I) log.

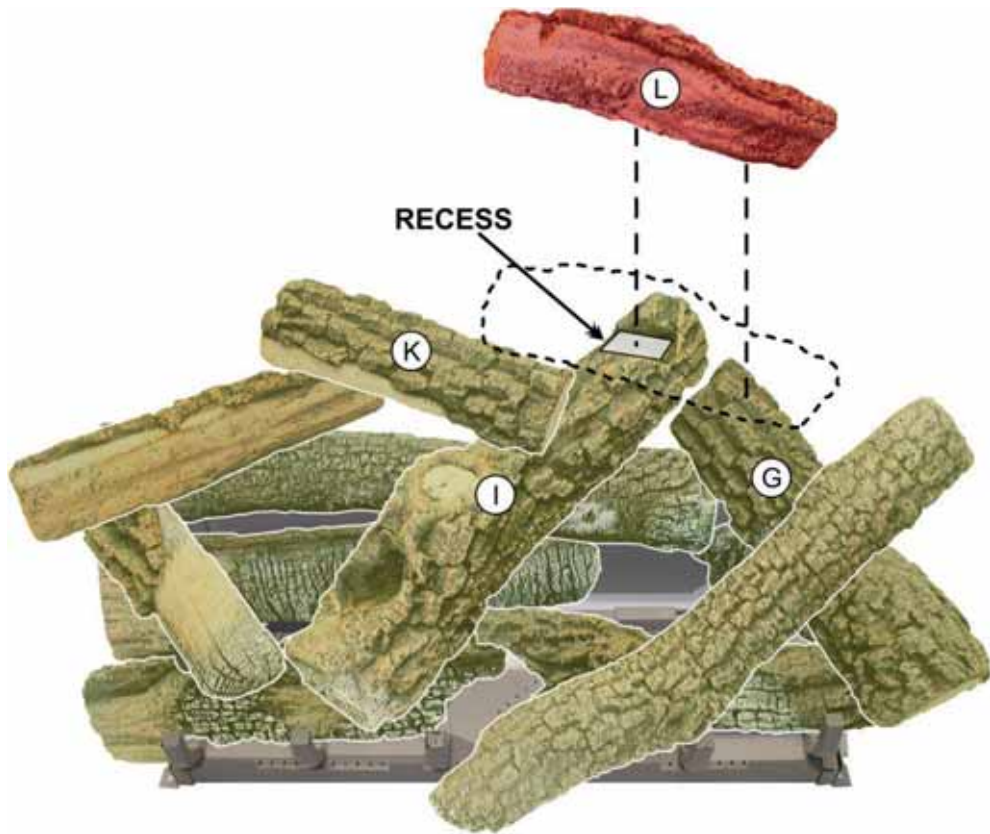

**FRONT VIEW**

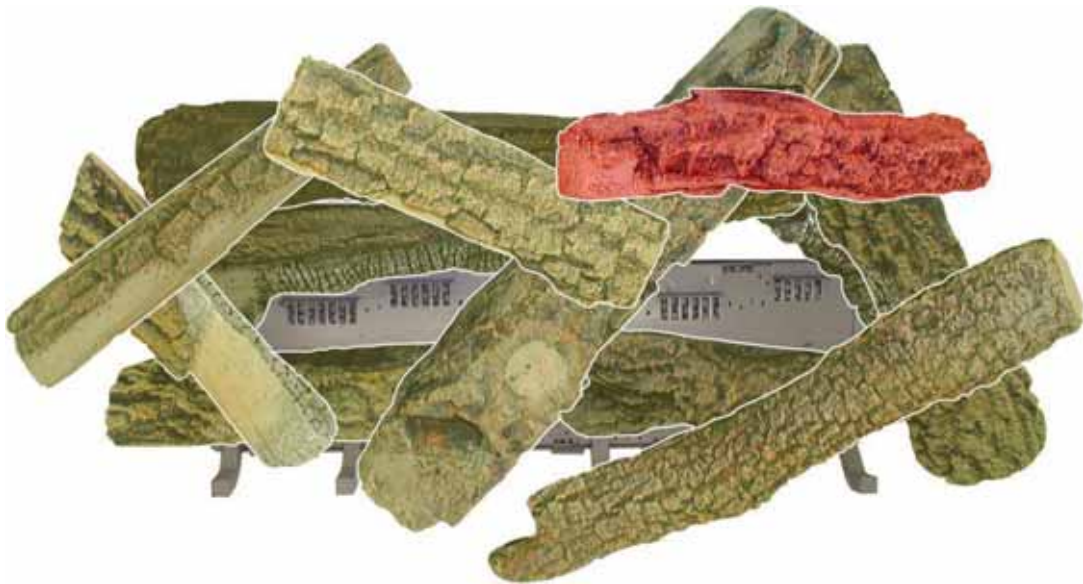

**TOP VIEW**

# LOG PLACEMENT

13. On LS-18P and LS-30P log sets, insert boss in top left (M) log onto recess on middle center (I) log and rest on upper middle left (J) log.

13. On LS-24P log sets, insert boss in top left (M) log onto recess on middle center (I) log and rest on middle left (F) log.

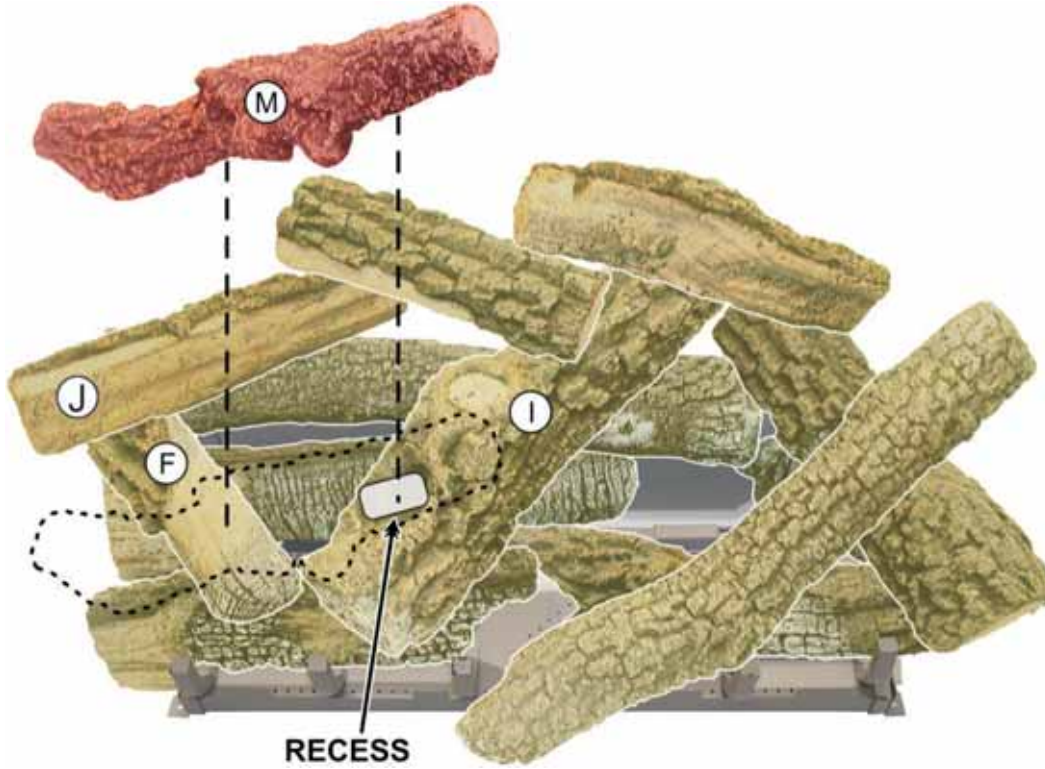

**FRONT VIEW**

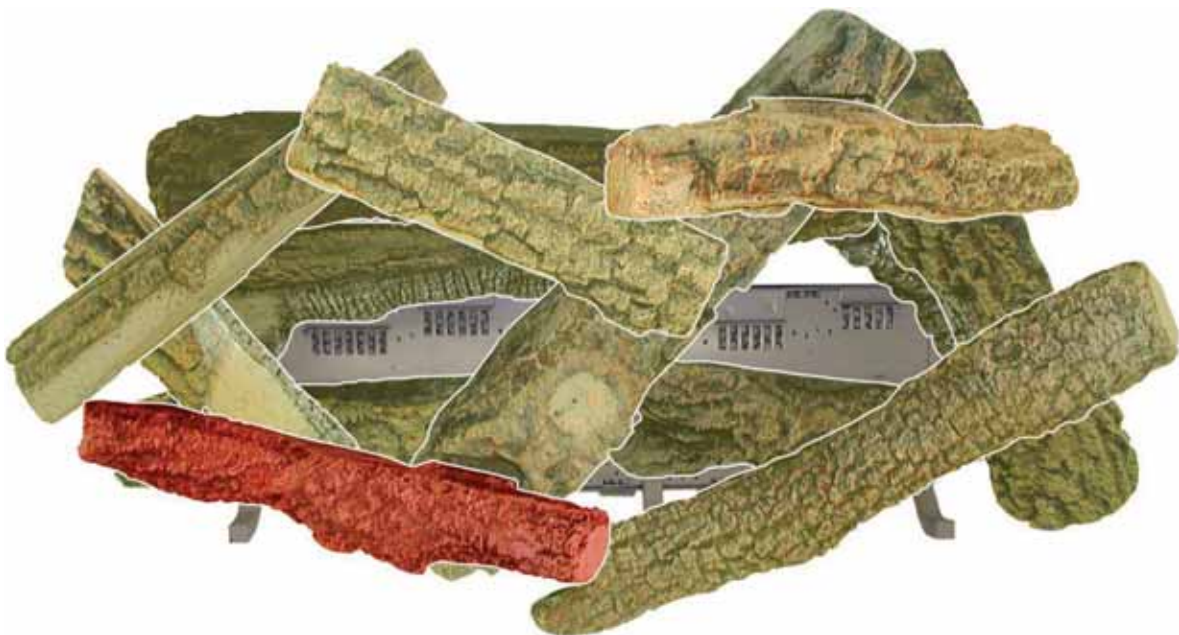

**TOP VIEW**

# LOG PLACEMENT

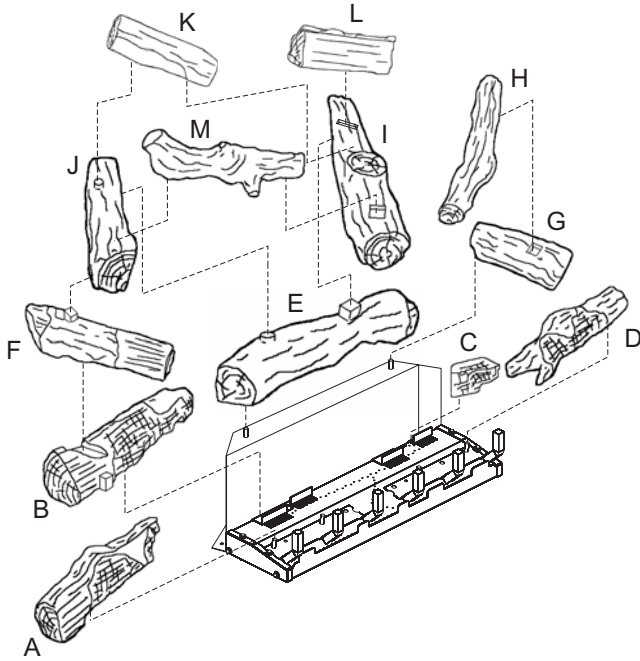

**Log Placement**  
**LS-(18, 24, 30)P Logs**  
**Figure 1**



























**Attention:** Do not use Pages 5-16 to order replacement logs. Refer to Page 17, Parts List and Parts View to order logs for your appropriate model number.

The following WARNING applies when log set is installed onto an unvented gas burner assembly.

**WARNING:** This appliance is equipped for (natural or propane) gas. Field conversion is not permitted.

# PARTS LIST & PARTS VIEW

**Attention:** When ordering parts, it is very important that **part number** and **description** of part coincide.

INDEX NO.	TOP VIEW	FRONT VIEW
A		
B		
C		
D		
E		
F		
G		
H		
I		
J		
K		
L		
M		

Index No.	Part No.			Description
	LS-18P-2	LS-24P-1	LS-30P-1	
A	R8353	R8361	R8368	Front Left Log
B	R8775	R8412	R8777	Rear Left Log
C	R8699	R8699	R8699	Rear Right Log
D	R8354	R8362	R8369	Front Right Log
E	R8355	R8363	R8370	Rear Center Log
F	R8413	R9020	R8778	Middle Left Log
G	R8700	R8700	R8700	Middle Right Log
H	R8776	R8198	R8779	Upper, Middle Right Log
I	R9880	R9019	R8367	Middle Center Log
J	R8774	R8379	R8379	Upper, Middle Left Log
K	R8364	R8364	R8371	Top Center Log
L	R8366	R8366	R8366	Top Right Log
M	R8365	R8365	R8372	Top Left Log

## PLACEMENT OF GLOWING EMBERS LS-18P-2

Do not cover any large rear ports with glowing embers.

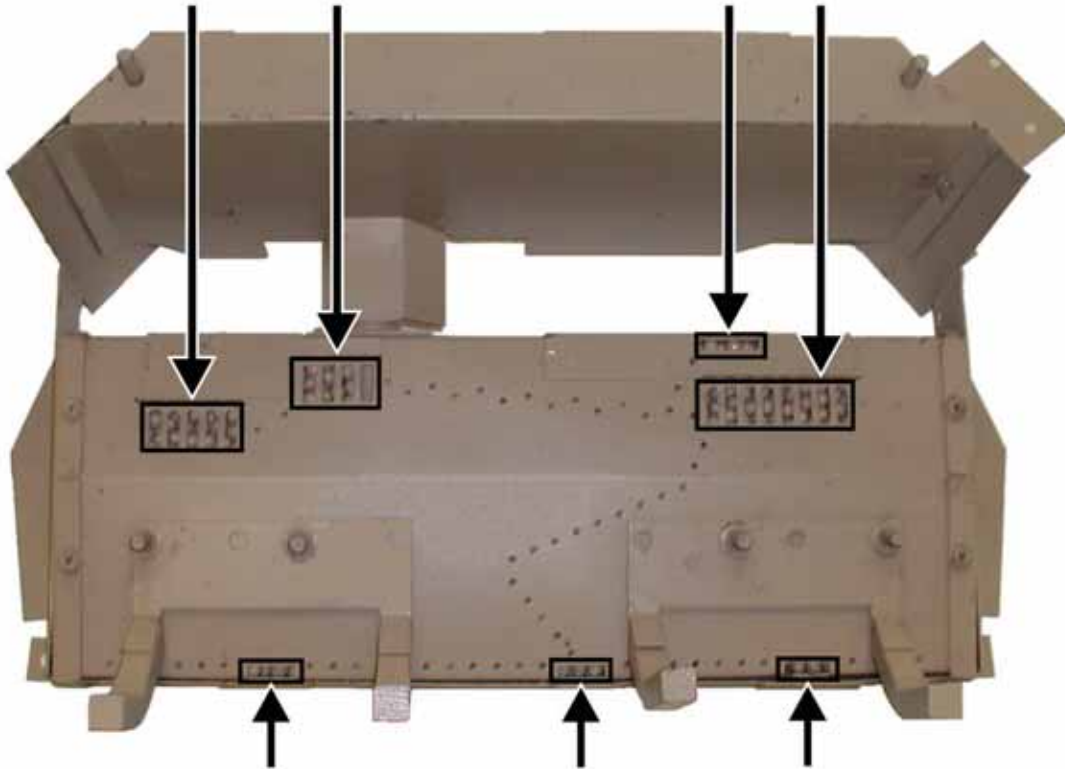

Do not cover any large front ports with glowing embers.

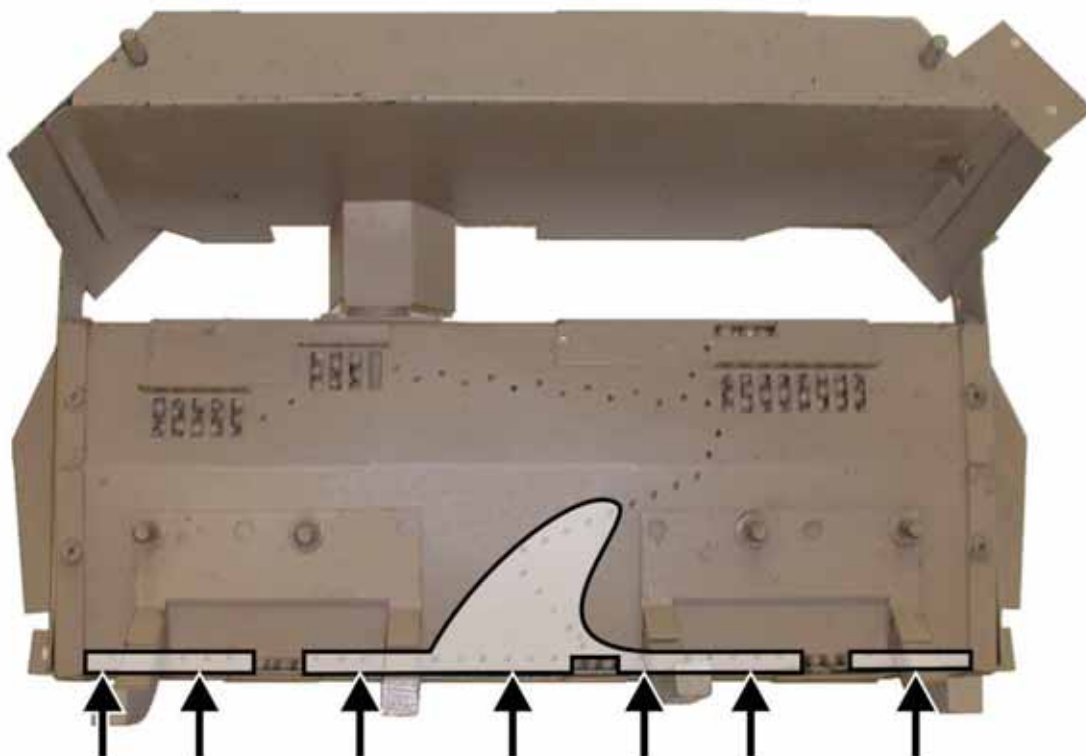

Area for glowing embers.

## PLACEMENT OF GLOWING EMBERS LS-18P-2

Do not cover any large rear ports with glowing embers.

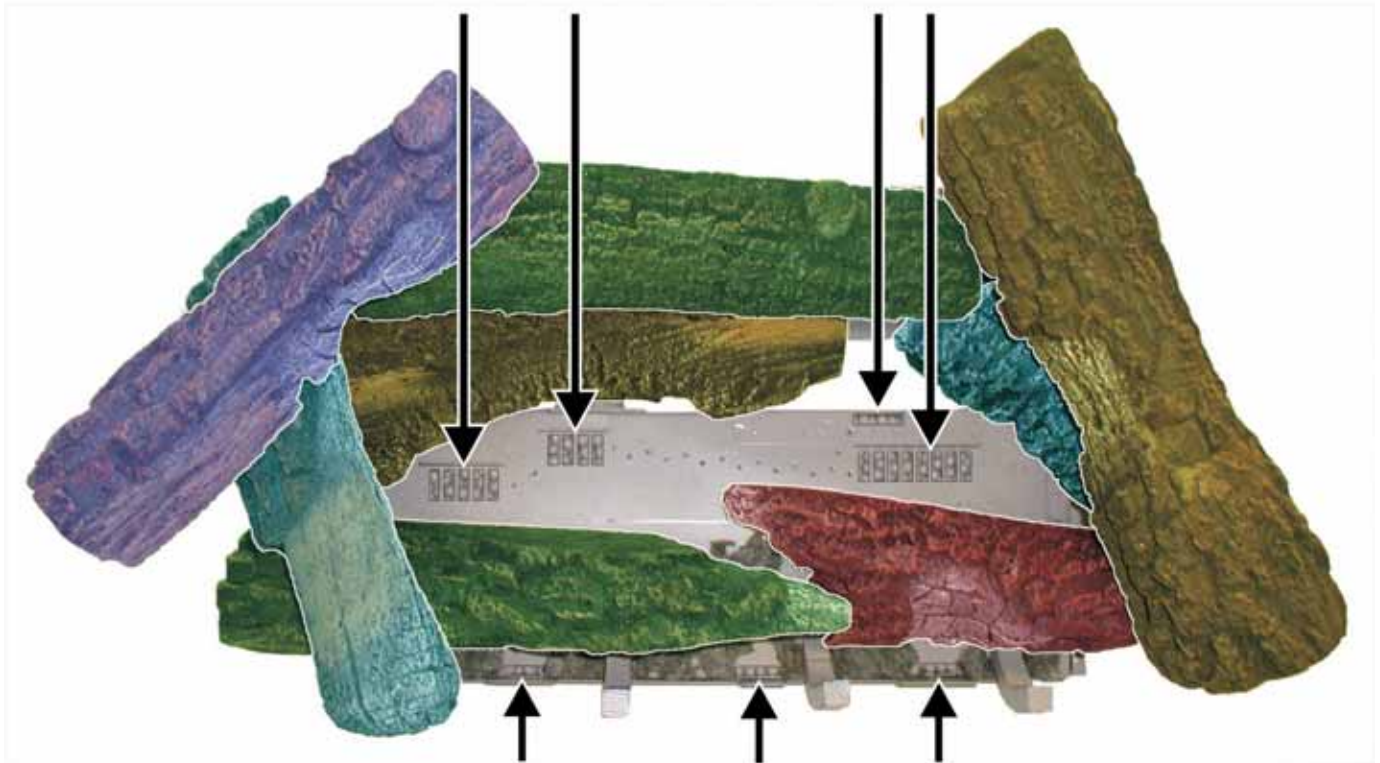

Do not cover any large front ports with glowing embers.

Some logs removed for clarity.

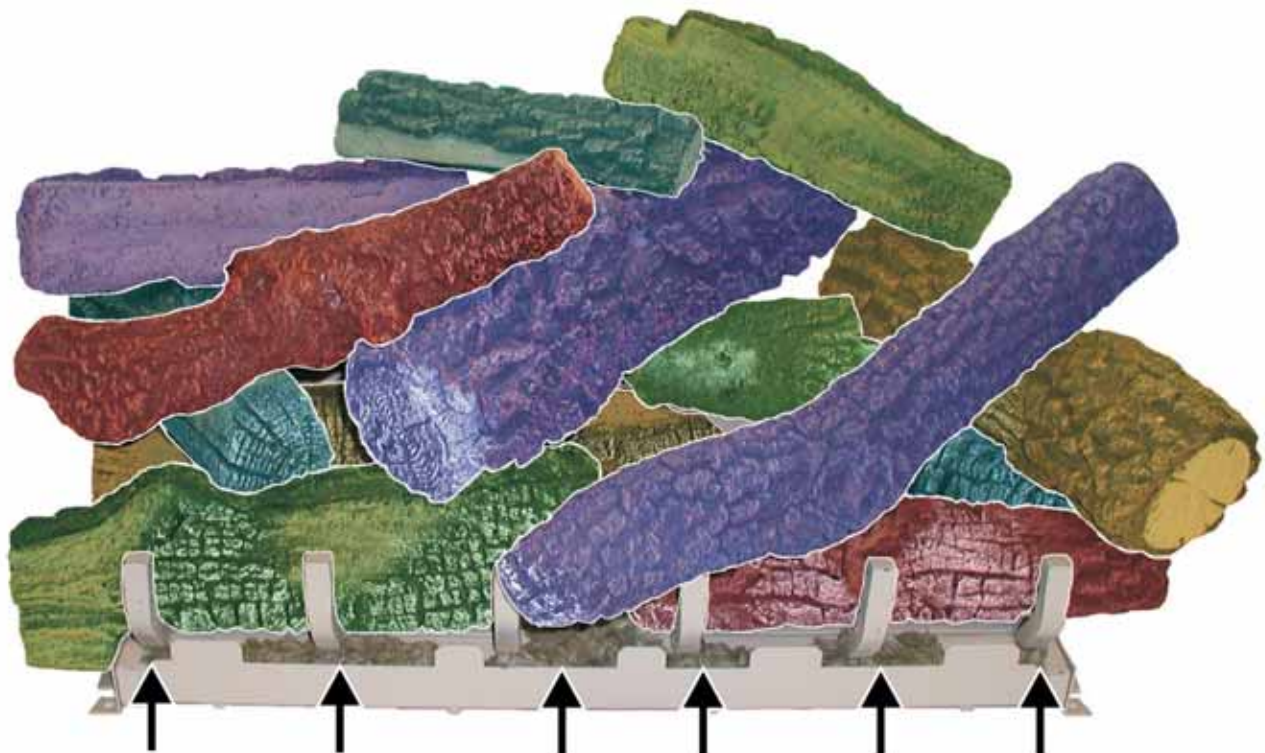

Area for glowing embers.

## PLACEMENT OF GLOWING EMBERS LS-24P-1

Do not cover any large rear ports with glowing embers.

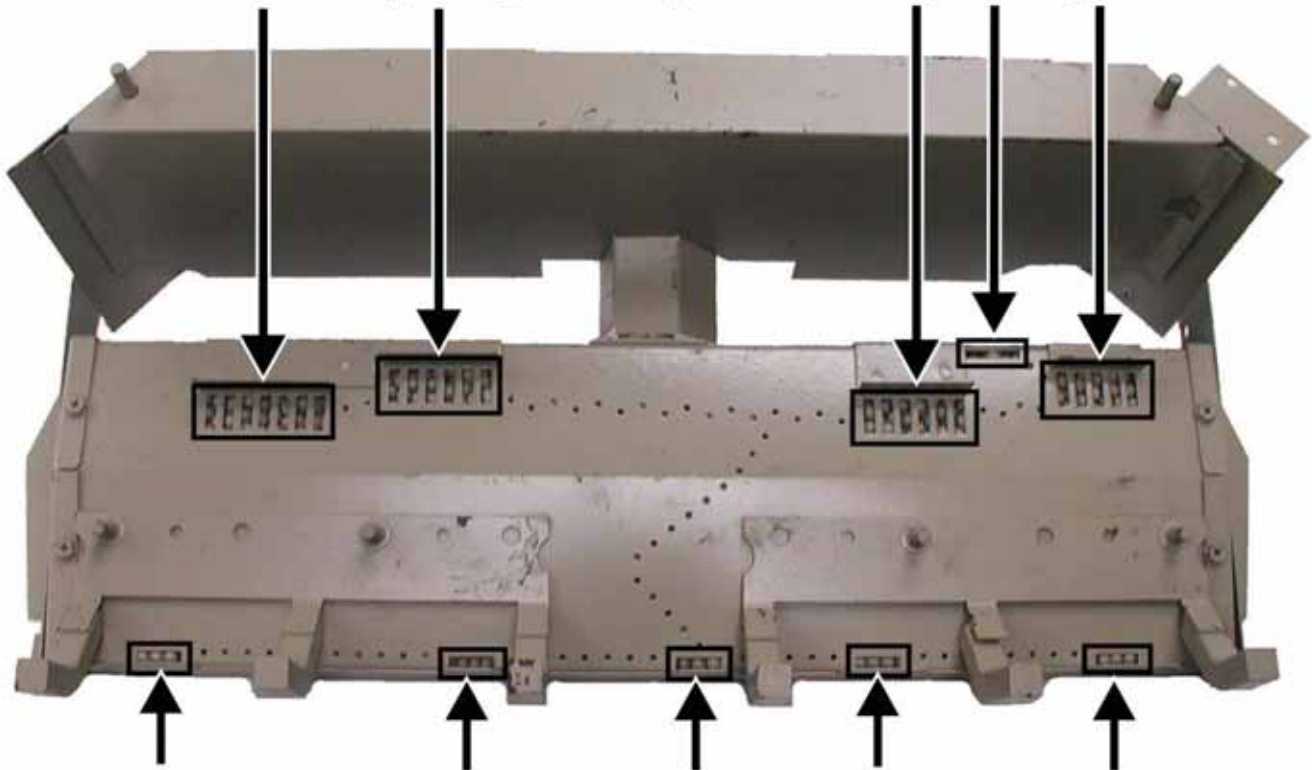

Do not cover any large front ports with glowing embers.

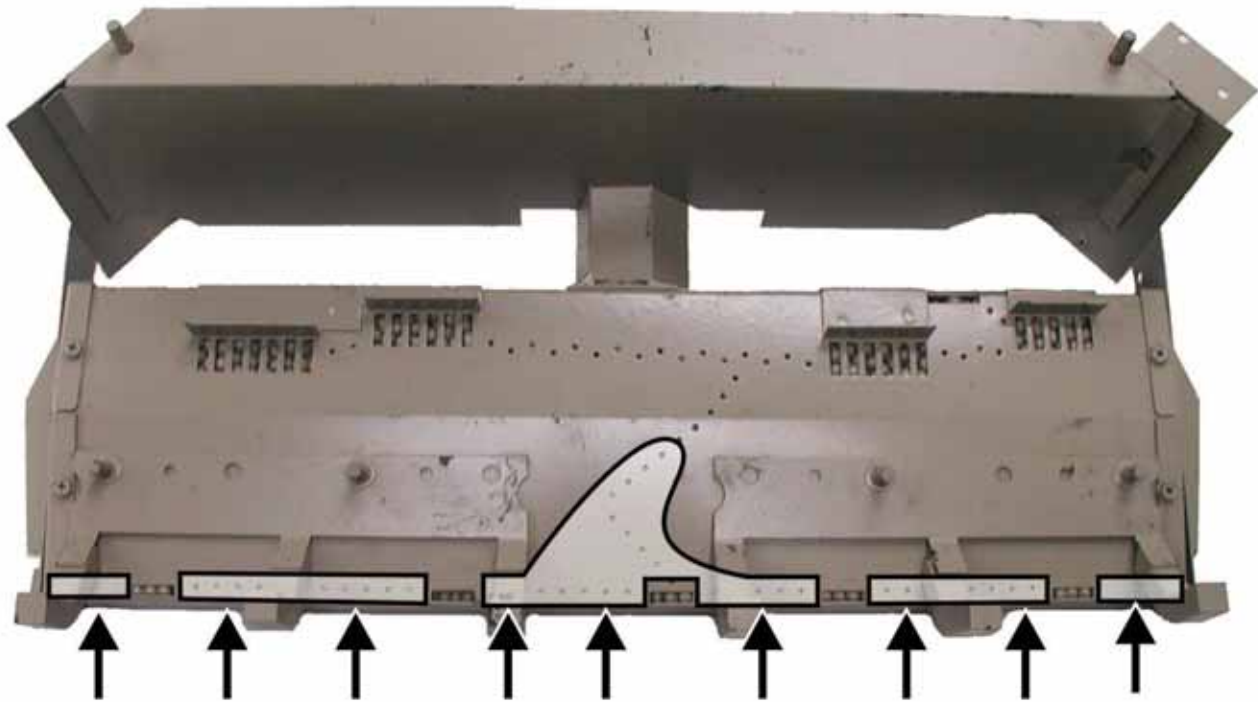

Area for glowing embers.

# PLACEMENT OF GLOWING EMBERS LS-24P-1

Do not cover any large rear ports with glowing embers.

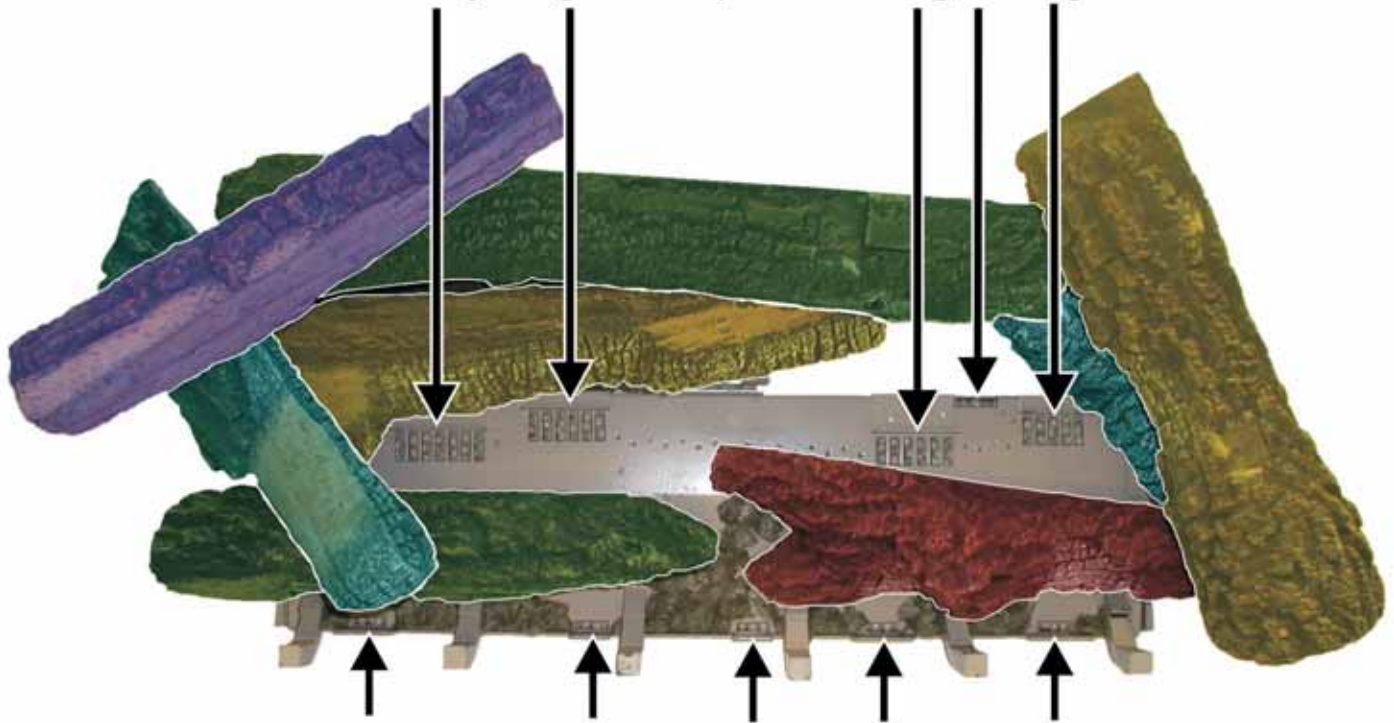

Do not cover any large front ports with glowing embers.

Some logs removed for clarity.

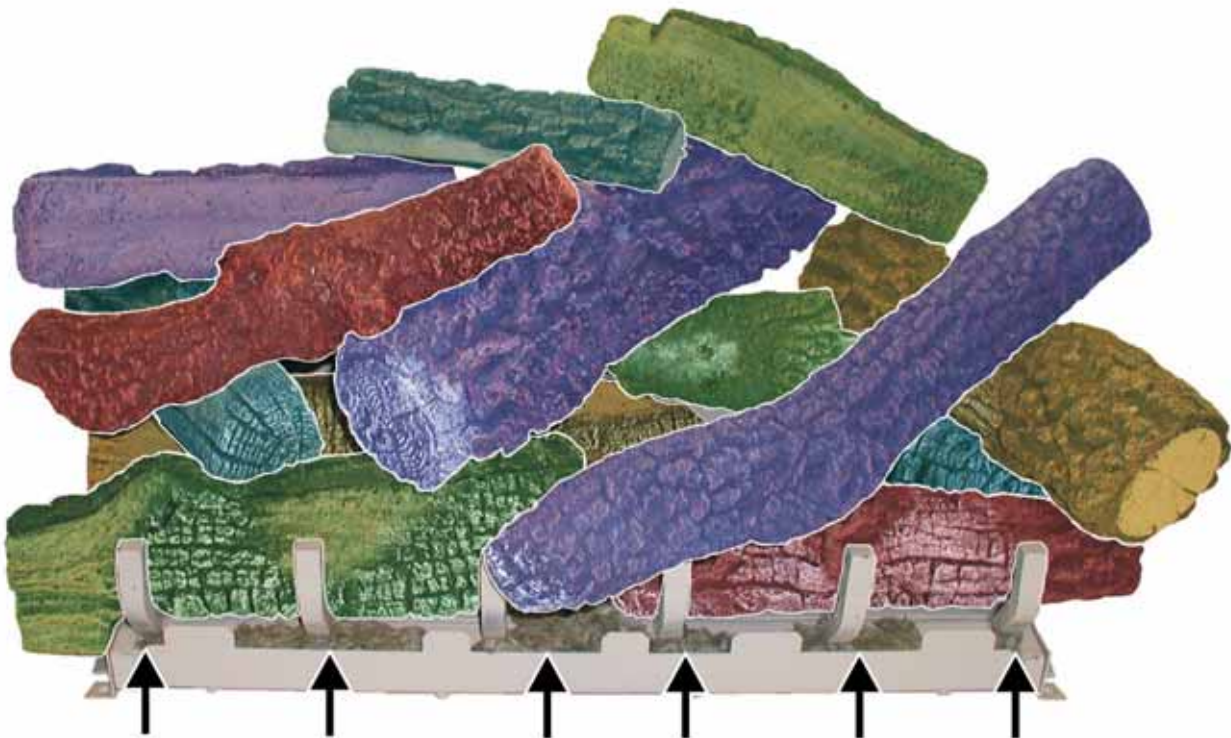

Area for glowing embers.

# PLACEMENT OF GLOWING EMBERS LS-30P-1

Do not cover any large rear ports with glowing embers.

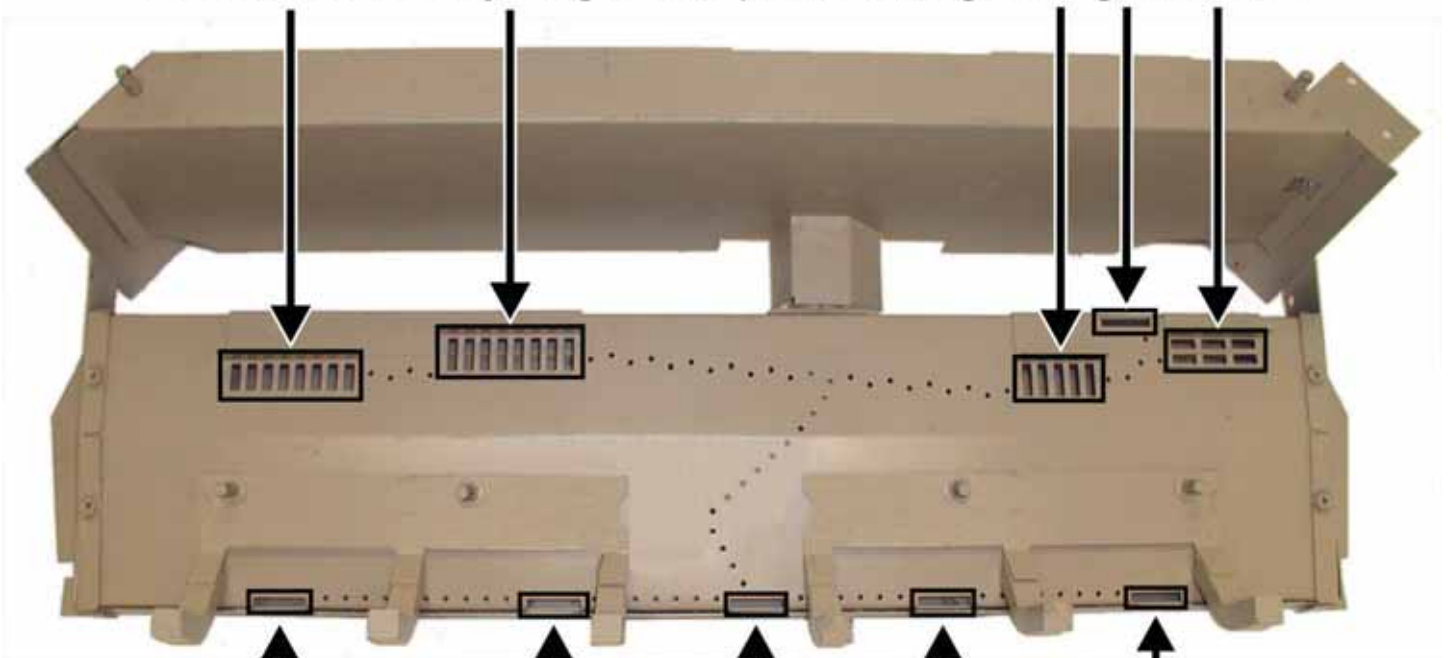

Do not cover any large front ports with glowing embers.

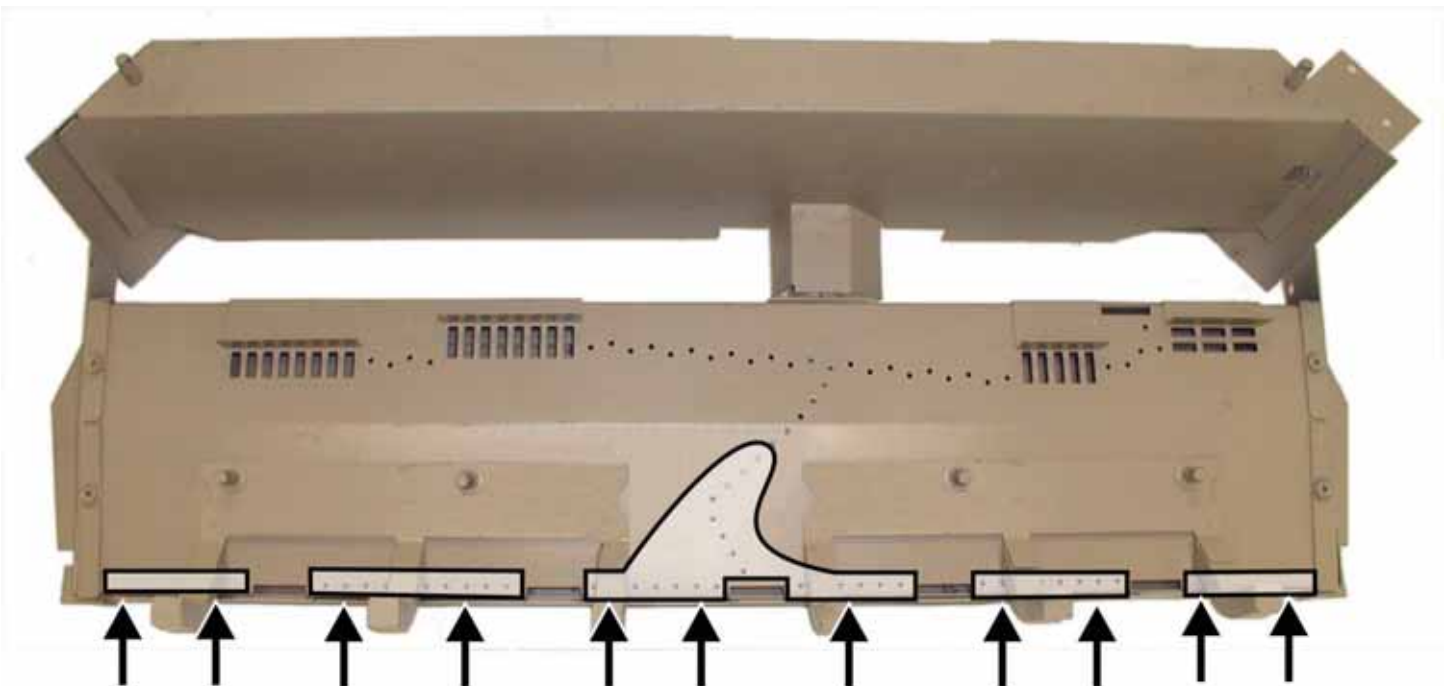

Area for glowing embers.

# EMBER PLACEMENT LS-30P-1

Do not cover any large rear ports with glowing embers.

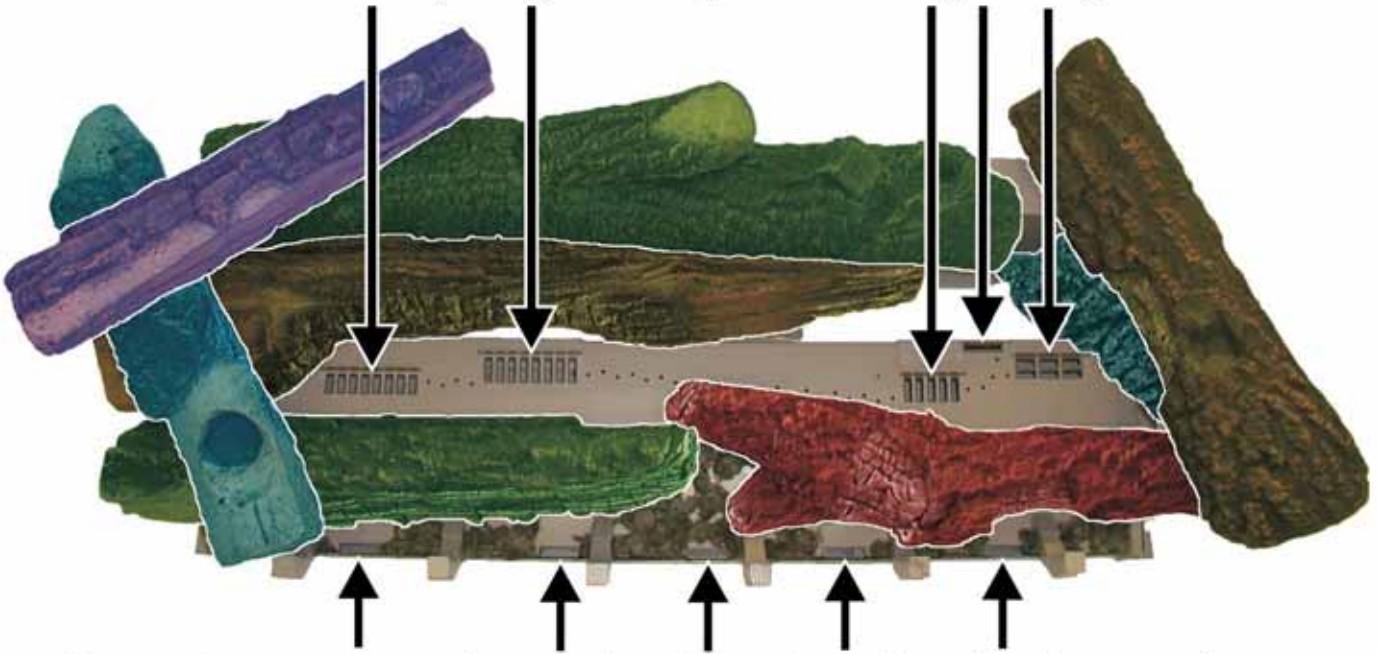

Do not cover any large front ports with glowing embers.

Some logs removed for clarity.

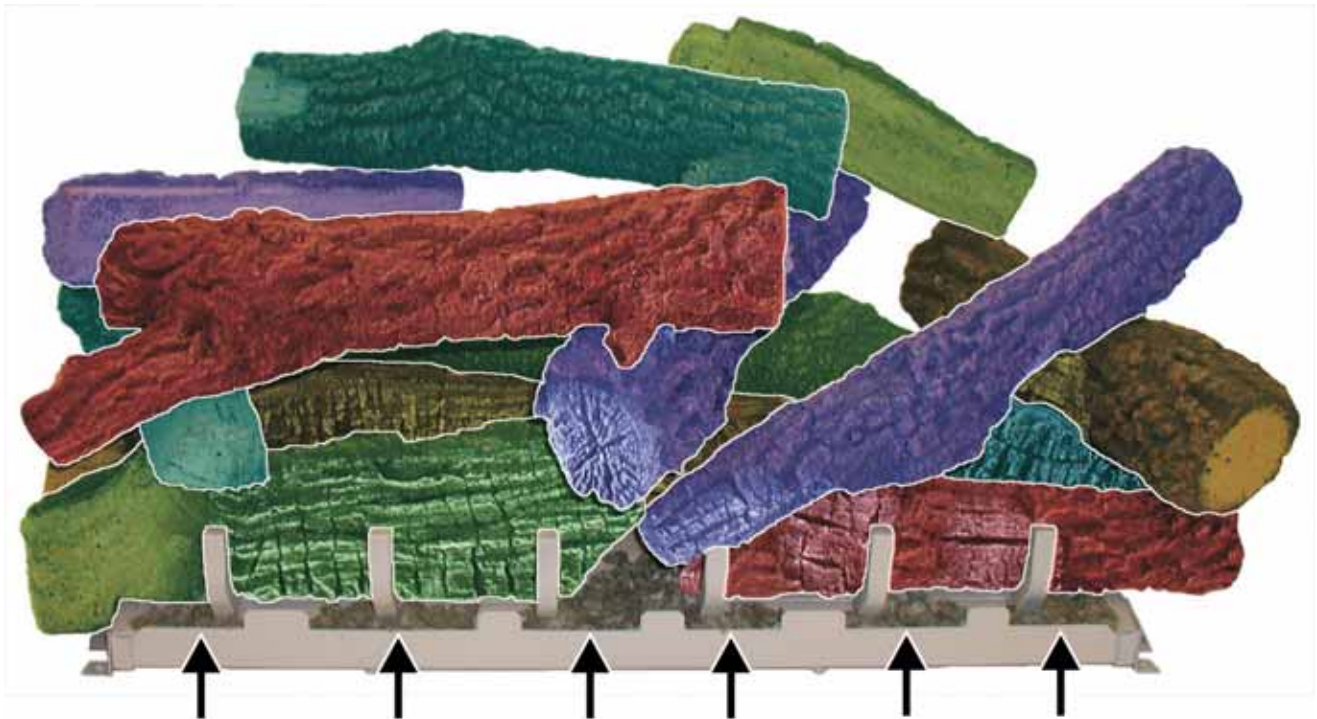

Area for glowing embers.

# PLACEMENT OF GLOWING EMBERS

Replacement glowing embers must be purchased from Empire Comfort Systems, Inc. Application of excess glowing embers may adversely affect performance of the heater, possibly causing soot.

**WARNING:** All previously applied glowing embers must be removed prior to reapplication of new embers.

## Replacement glowing embers Part Number

LS-18P	15999
LS-24P	15970
LS-30P	15970
Platinum Bright Embers	PE-20

**Note:** A single layer of glowing embers is to be used when applying Platinum Bright Embers (alone or in combination with production embers) to the burner.

Separate the ember material by hand and make the coverage as light and fluffy as possible.

Place just enough embers on the burner to obtain the glow and a gold, yellow flame.

Do not place glowing embers over large ports in front or rear portion of burner.

Glowing embers should not be placed in the area of the pilot assembly.

# MASTER PARTS DISTRIBUTOR LIST

To Order Parts Under Warranty, please contact your local Empire dealer. See the dealer locator at [www.empirecomfort.com](http://www.empirecomfort.com). To provide warranty service, your dealer will need your name and address, purchase date and serial number, and the nature of the problem with the unit.

To Order Parts After the Warranty Period, please contact your dealer or one of the Master Parts Distributors listed below. This list grows from time to time. For the current list, please click on the Master Parts button at [www.empirecomfort.com](http://www.empirecomfort.com).

Please note: Master Parts Distributors are independent businesses that stock the most commonly ordered Original Equipment repair parts for Heaters, Grills, and Fireplaces manufactured by Empire Comfort Systems Inc.

## Star-Fire Distributors

1355 Evans Avenue  
Akron, OH 44305

**Phone:** 330-630-2794

**Toll Free:** 800-875-6220

**Fax:** 330-633-8701

**Parts: Heater & Hearth and Grills**

## Dey Distributing

1401 Willow Lake Boulevard  
Vadnais Heights, MN 55101

**Phone:** 651-490-9191

**Toll Free:** 800-397-1339

**Website:** [www.deydistributing.com](http://www.deydistributing.com)

**Parts: Heater & Hearth**

## East Coast Energy Products

10 East Route 36  
West Long Branch, NJ 07764

**Phone:** 732-870-8809

**Toll Free:** 800-755-8809

**Fax:** 732-870-8811

**Website:** [www.eastcoastenergy.com](http://www.eastcoastenergy.com)

**Parts: Heater & Hearth and Grills**

## Victor Division of F. W. Webb Company

200 Locust Street  
Hartford, CT 06114

**Phone:** 860-722-2433

**Toll Free:** 800-243-9360

**Fax:** 860-293-0479

**Toll Free Fax:** 800-274-2004

**Websites:** [www.fwwebb.com](http://www.fwwebb.com) & [www.victormfg.com](http://www.victormfg.com)

**Parts: Heater & Hearth and Grills**

# HOW TO ORDER REPAIR PARTS

## Parts Not Under Warranty

Parts can be ordered through your Service Person, Dealer, or a Master Parts Distributor. See this page for the Master Parts Distributors list. For best results, the **service person or dealer** should order parts through the distributor. Parts can be shipped directly to the **service person/dealer**.

## Warranty Parts

Warranty parts will need a proof of purchase and can be ordered by your Service Person or Dealer. Proof of purchase is **required** for warranty parts.

All parts listed in the Parts List have a Part Number. When ordering parts, first obtain the Model Number from the name plate on your equipment. Then determine the Part Number (**not** the Index Number) and the Description of each part from the following appropriate illustration and list. Be sure to give all this information . . .

Appliance Number \_\_\_\_\_ Part Description \_\_\_\_\_

Appliance Serial Number \_\_\_\_\_ Part Number \_\_\_\_\_

Type of Gas (Propane or Natural) \_\_\_\_\_

Do not order bolts, screws, washers or nuts. They are standard hardware items and can be purchased at any local hardware store.

Shipments contingent upon strikes, fires and all causes beyond our control.







Empire Comfort Systems Inc.  
918 Freeburg Ave. Belleville, IL 62220

If you have a general question about our products, please e-mail us at  
[info@empirecomfort.com](mailto:info@empirecomfort.com).

If you have a service or repair question, please contact your dealer.

[www.empirecomfort.com](http://www.empirecomfort.com)